

# REACTION TIME AND NEURAL CIRCUITRY

## Directions for Teachers

### SYNOPSIS

In this activity students perform four card-sorting tasks to learn about the role of neural circuitry in human reaction time. They then design and test their own experiments to examine other factors that influence reaction time.

### LEVEL



Exploration Phase



Concept/Term Introduction, Application Phases

### Getting Ready

See sidebars for additional information regarding preparation of this lab.

### Directions for Setting Up the Lab

#### & Exploration and Application

- Assign student lab groups to bring in decks of playing cards, or purchase these.
- Locate and obtain materials.
- Make transparencies and/or photocopies of Figures 4a through 4d.

### Teacher Background

We take many everyday actions for granted, from blinking our eyes to picking up a pencil to driving a car. Most actions, except for the simplest reflexes, involve a large amount of brain activity: receiving and processing sensory information, integrating and interpreting that information, and controlling of muscle activity to produce movements in response to the information. This learning activity allows students to discover that more complex tasks require longer processing time, reflecting the increased activity in the brain.

*Reaction time* is the amount of time required for the nervous system to receive and integrate incoming sensory information and then cause the body to respond. The simplest example of reaction time is the time required for a simple reflex to occur. In this activity, a relatively simple task will be used in place of a reflex response. In Task 1, students will be required simply to deal cards randomly into two piles. This is a simple repetitive motor task involving a relatively uncomplicated neuronal circuit with few synapses, such as that shown in Figure 1. *Note: All the tasks described in this lab, even those involving random sorting, are more complex than the monosynaptic knee-jerk reflex described below.*

**Rebecca Sacra**  
McLean High School  
1633 Davidson Street  
McLean, VA 22101

### STUDENT PRIOR KNOWLEDGE

Before participating in this activity students should be able to:

- Define each of the following terms and explain the relationships among the terms: neuron, neurotransmitter, synapse, axon.

### INTEGRATION

*Into the Biology Curriculum*

- Health
- Biology I, II
- Anatomy and Physiology
- AP Biology

*Across the Curriculum*

- Computer Science

### OBJECTIVES

At the end of this activity students will be able to:

- Explain in very general terms the complexity of sensory stimuli and processing by the brain.
- Demonstrate using simple activities the effect of the brain's differing approaches to task complexity and reaction time.

## LENGTH OF LAB

A suggested time allotment follows:

### Day 1

- E** 15 minutes — Perform and discuss Task 1.
- 20 minutes — Perform Tasks 2, 3, and 4.
- C** 10 minutes — Draw bar graphs.

### Day 2

- C** 20 minutes — Discuss results of tasks in groups and as a class.
- 25 minutes — Draw models in groups, share results with the class.

### Day 3

- A** 15 minutes — Write hypothesis and procedure to test it.
- 30 minutes — Test hypothesis.

## TEACHING TIPS

### MATERIALS NEEDED

- E** You will need the following for each group of four students in a class of 24:
  - 1 deck of playing cards
  - 1 watch/clock with a second timer

### PREPARATION TIME REQUIRED

- E & A**
  - 1 hour to purchase playing cards, if students will not be bringing these in.
  - 1 hour to locate and obtain watches/clocks.
- C** ■ 1/2 hour to make transparencies and/or photocopies of Figures 4a through 4d.

**SAFETY NOTES**  
None needed.

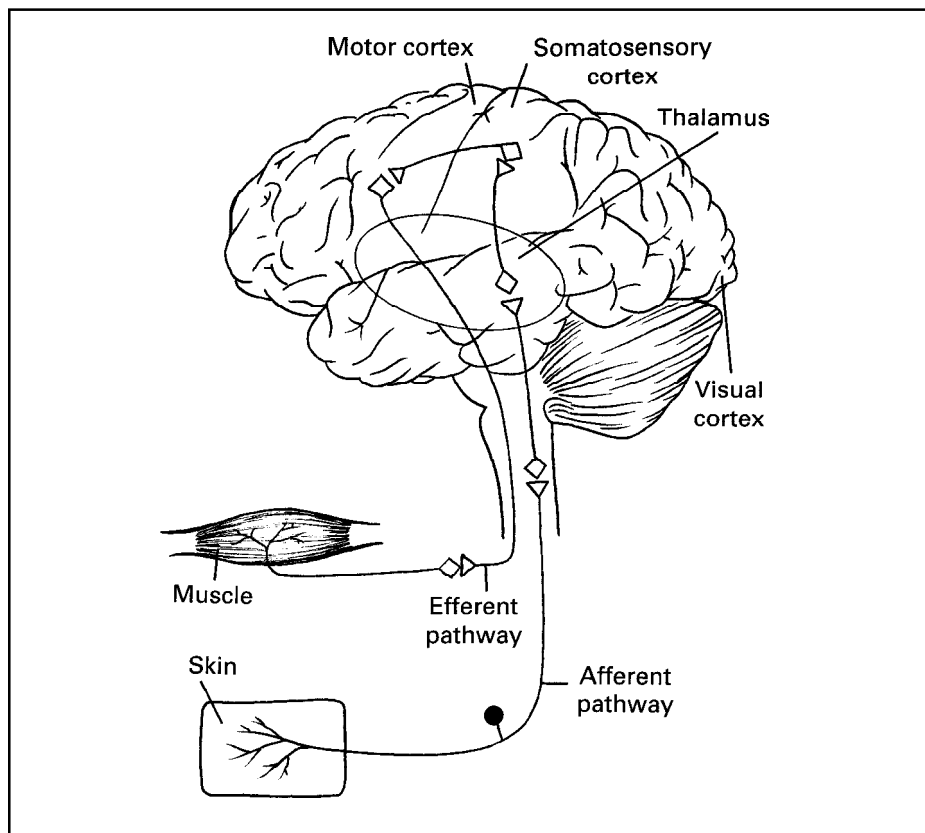

Figure 1. A nerve pathway that involves several areas of the brain. Note the number of synapses involved.

The procedure becomes more complicated in Task 2 as the student must now separate the cards into two piles: one for red suits and one for black suits. The reaction time, or the time to complete the task, will increase for Task 2 as the student now must process more information. The brain must differentiate between the red and black suits on the cards, then send a command to activate the appropriate muscles to move the arm and hand to the right spot for the cards. The information will be received by the brain in the *visual cortex* (see Figure 2) and sent to the *association cortex* where the sensory signal will be interpreted and associated with a memory of where to put the card.

This new information then goes to the motor cortex where it initiates a signal that is transmitted down the spinal cord and out to the muscles to move the arm and hand to place the card in the correct pile. The time required to make the distinction between red or black cards is called the *discrimination time*.

The simplest reflex involves only two neurons and one synapse (*monosynaptic*). This reflex is commonly observed as the knee-jerk reflex, which occurs when the tendon just below the kneecap is tapped. This stimulus in turn causes the muscle to contract, moving the leg. (For more information on this reflex, including a diagram, refer to “What’s the Connection?” on p. 59.) The reflex does not require any brain activity, as the

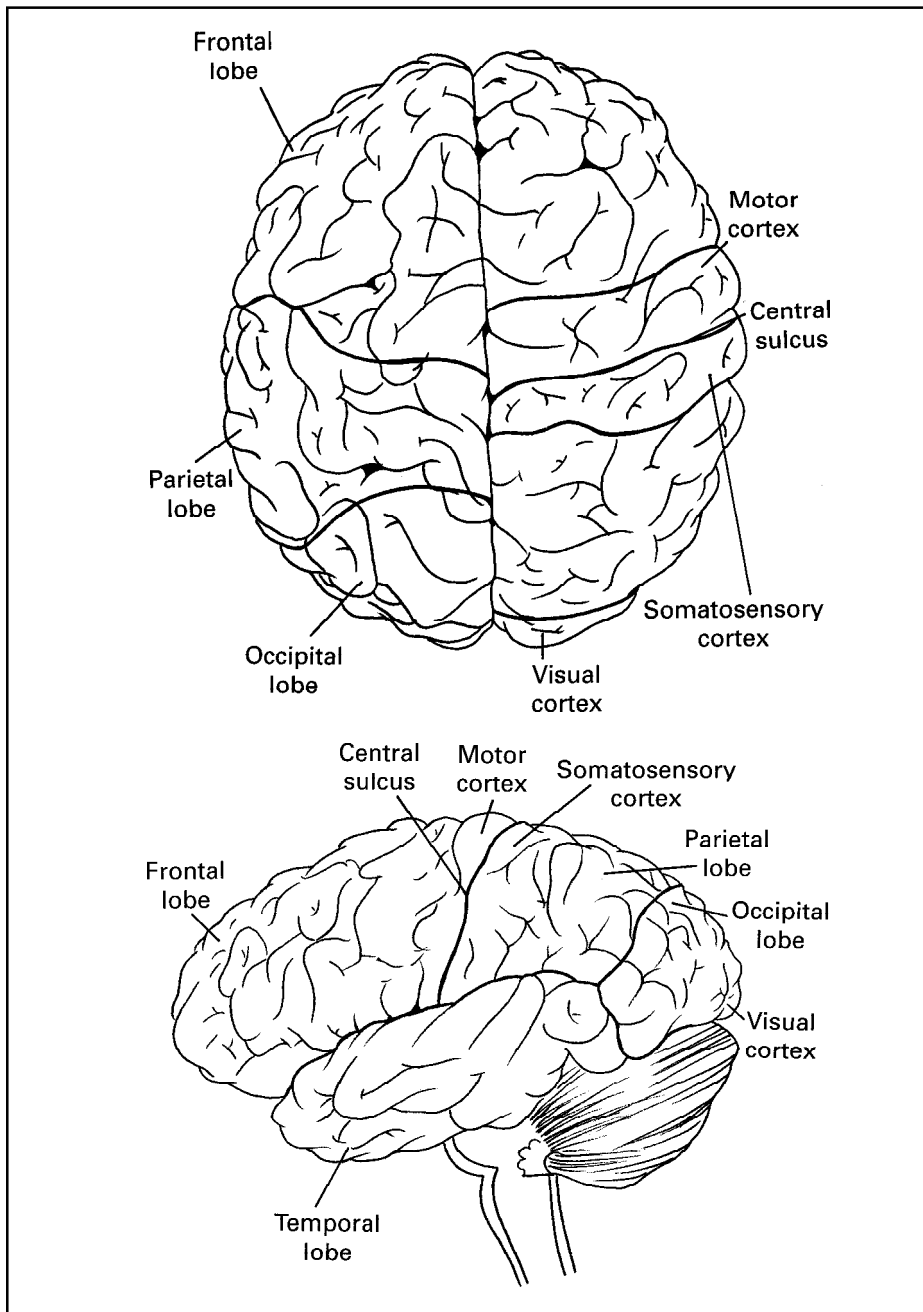

Figure 2. Major divisions of the human cerebral cortex: (a) dorsal view, (b) lateral view of left hemisphere.

circuitry is contained within the spinal cord itself. If one were to concentrate on holding the leg still, then the reaction time and degree of response would change. In a like manner, if the task is a simple rote memory task, like reciting the multiplication tables, then it can be done almost reflexively. If the task involves some discrimination process (thinking), then it will be even slower. If a distraction is introduced, such as dealing the cards into two piles while reciting multiplication tables, then the discrimination time and reaction time will both be increased.

- To save the cost of the cards, have students bring in their own decks of cards.
- In some cultures, students are not allowed to use or even touch playing cards. Teachers may need to determine before planning this lab if any of their students will be unable to work with playing cards. Alternative activities can be planned for these students, such as:
  - simple computer programs with corresponding pen and paper exercises, described on page 227.
  - flash cards made for numbers, with different colors, numbers, and/or objects represented. These are available at toy stores and school supply stores.

#### SUGGESTED MODIFICATIONS FOR STUDENTS WHO ARE EXCEPTIONAL

Below are possible ways to modify this specific activity for students who have special needs, if they have not already developed their own adaptations. General suggestions for modification of activities for students with impairments are found in the AAAS *Barrier-Free in Brief* publications. Refer to p. 19 of the introduction of this book for information on ordering **FREE** copies of these publications. Some of these booklets have addresses of agencies that can provide information about obtaining assistive technology, such as Assistive Listening Devices (ALDs); light probes; and

— Continued

**SUGGESTED MODIFICATIONS**  
— Continued

talking thermometers, calculators, and clocks.

**Blind or Visually Impaired**

- If a student who is blind or who has low vision participates as the card sorter, he/she can bring in braille or large numeral cards from home, if available. Alternatively, produce a “deck” by using 5 x 7 inch index cards with four different tactile symbols representing suits and two different suits indicating color. These could be produced by making different dot/symbol patterns with glue or applying different fabric, sandpaper, or textures for the student who is blind, or large numerals for the students with low vision.

- A student who is blind could participate as the timer by using a talking clock or braille wristwatch.
- Students who are blind can make a bar graph using graph sheets from the American Printing House for the Blind. These sheets are available in 1/2-, 3/4-, and 1-inch squares.

**Mobility Impaired**

- A student who has limited use of his/her arms and/or hands might be aided by using 5 x 7 inch cards with appropriate symbols. If these cards are not available, this student could participate as the data recorder for the card sorting activities.

— Continued

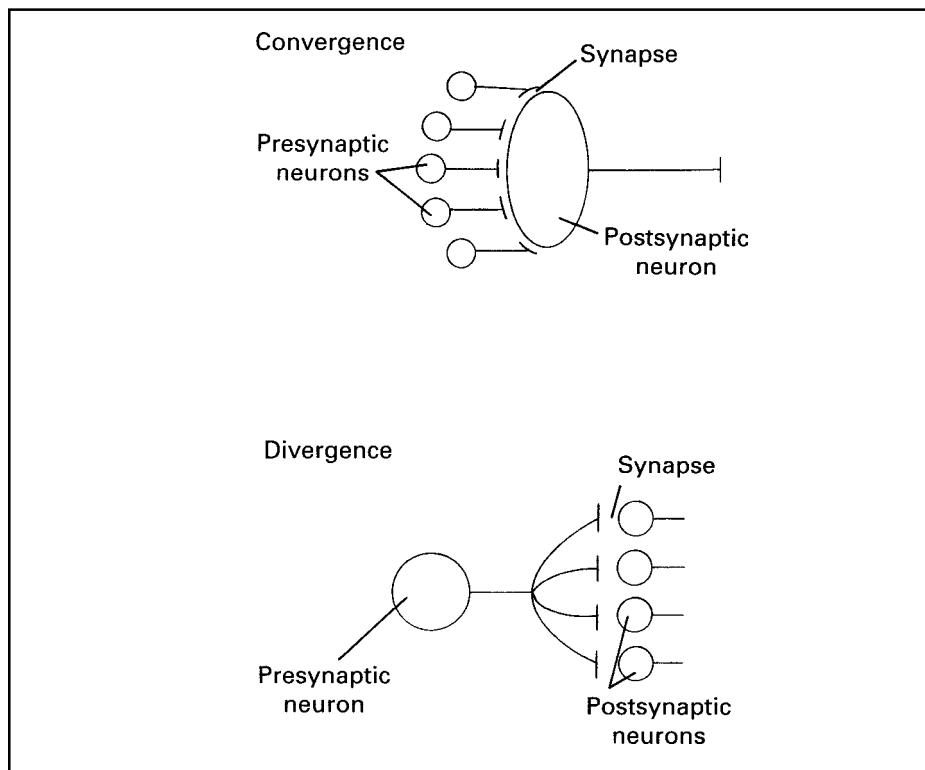

Figure 3. Convergence and divergence of neuronal signals.

Discrimination time will increase with the increased complexity of a task. As the task becomes more complex, more things must be considered and compared, allowing for more options and decisions to be made. In the brain this means more neurons are involved. Neurons communicate with each other through a synapse. It requires a minimum of 0.5 millisecond for the signal to cross a synapse (Guyton, 1991, p. 493) and cause some change in the activity of the second or postsynaptic neuron. Since the postsynaptic neuron is also receiving information from other neurons (*convergence*) it will take even longer to process all of the signals. See Figure 3.

This processing of the various signals is called *integration*. The signals from one neuron will influence the activity in the second neuron in one of two ways: (1) *excitation*, causing a new signal to be formed and passed on to other neurons, or (2) *inhibition*, preventing the formation of a new signal to be passed on to other neurons. Because a neuron is receiving a multitude of inputs from many other neurons, it will integrate all the inhibitory and excitatory information and the resultant action will be the sum of all the incoming information.

Students should understand the following concepts as a result of performing the activity:

Task 1 establishes a baseline for the time required to sort the cards randomly into two piles. Task 3 also establishes a baseline for sorting the cards randomly into four piles. Both of these tasks would represent a control for the experiment. The difference between Task 1 and Task 3 represents the

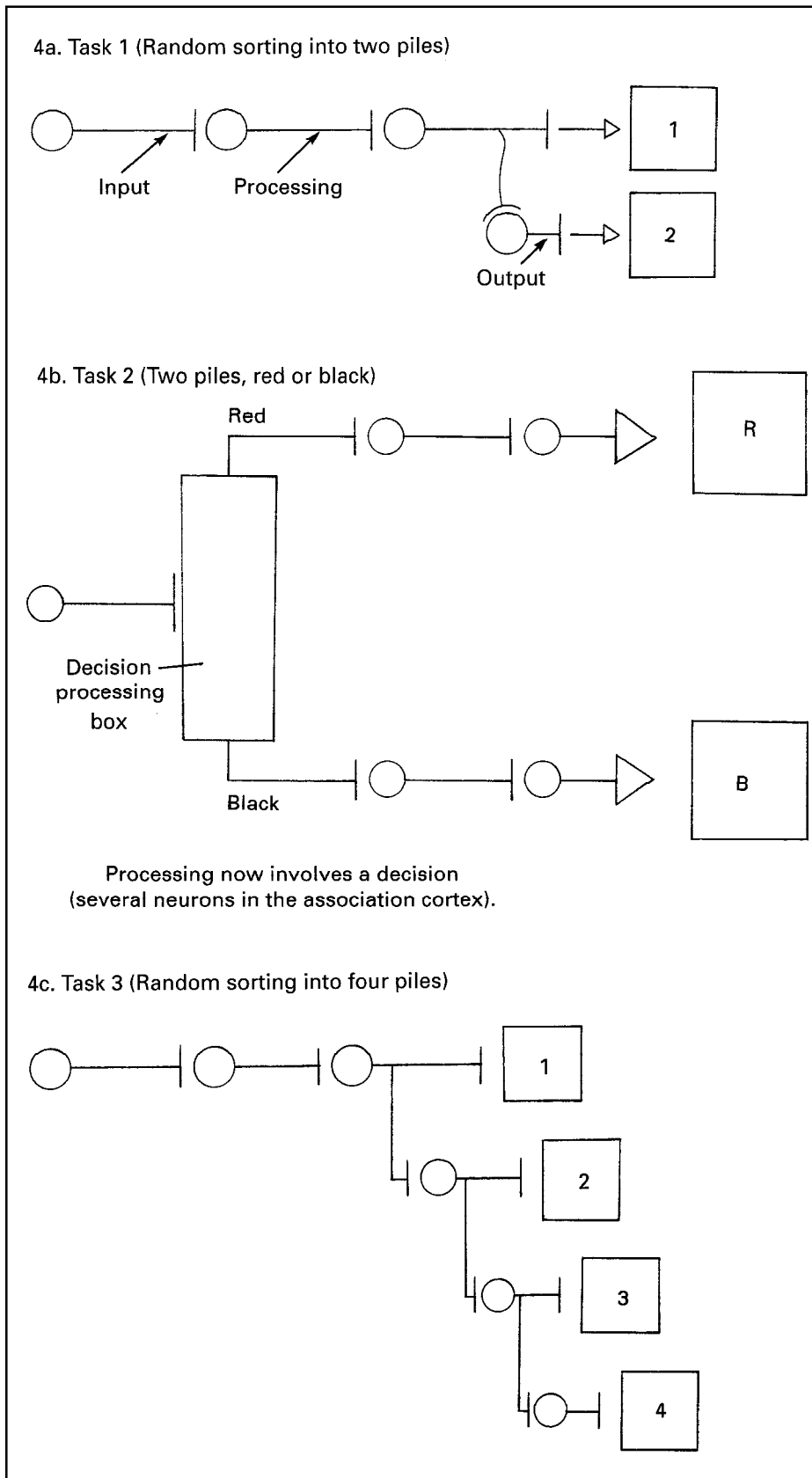

Figures 4a through 4d (4d on next page). Schematic diagrams of neural processes involved in card sorting tasks.

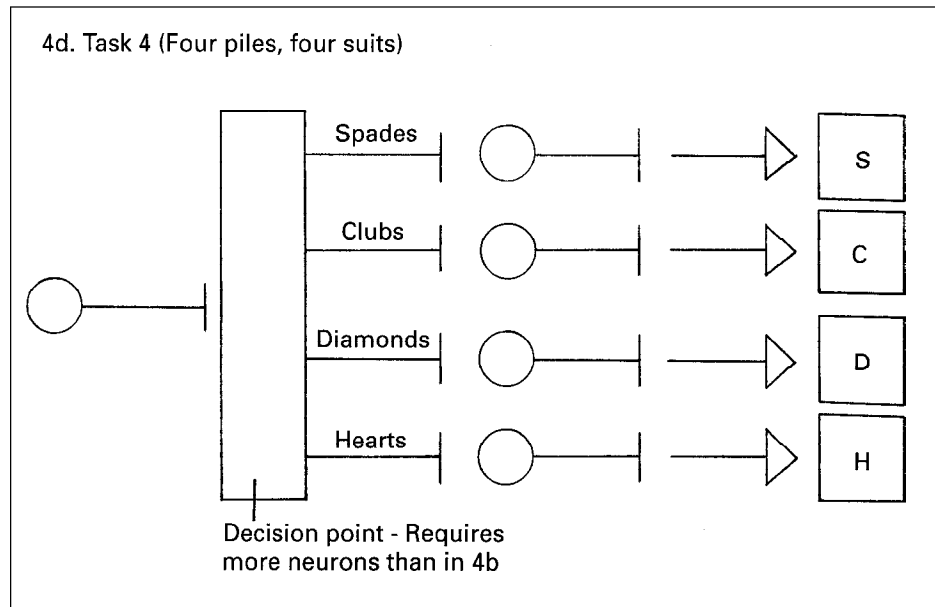

Figure 4a through 4d. Continued.

time required for the added motor output for a change in the arm and hand position. This is illustrated as additional steps in the circuit in Figure 4c. Since these steps add to the complexity of the circuit, they would be expected to add to the reaction time for the task.

Task 2 involves separating the cards into two piles by the color of the suits. This procedure will require a decision point in the processing of the information. The actual neuronal mechanism for the decision process is not well understood but is known to be complex and require at least several neurons within that part of the circuit. This is depicted as the Decision Processing Box in Figure 4b. The difference in time between Task 1 and Task 2 would represent the discrimination time, the time to make a decision as to the color of the suit on the card and which pile it goes with. Since the output involves movement into two piles, that part is the same as in Task 1. Task 2 is obviously a more complicated task, thus it will take a longer time.

Task 4 adds more decision points as each card will be placed in a pile determined by the individual suit. The complexity of the circuit in Task 4 is depicted in Figure 4d. The choices are now increased, so the discrimination time should further increase.

Students should conclude that two factors influenced the time for the various tasks: (1) the number of piles, Tasks 1 and 2 as compared to Tasks 3 and 4, and (2) sorting by color (Task 2) and suit (Task 4). Task 1 is the simplest in complexity followed by Task 3, Task 2, then Task 4. In general, you would expect the time for each procedure to reflect the degree of complexity.

## Procedure

### Exploration

Introduce this unit by informing students that they are going to have an opportunity to use playing cards in class and learn about the brain at the same time. Have them perform the following card sorting task in cooperative groups:

- **Task 1:** Sorting cards *randomly* into *two piles*
- Have students work in teams of four. Assign each student in the group with one of the following roles:
  - Card sorter
  - Observer
  - Timer
  - Data recorder.

Each group should follow these steps:

1. The card sorter should shuffle a full deck of cards well.
2. The observer should be positioned so that he/she can see the actions of the card sorter.
3. When the timer tells the sorter to begin, the sorter should deal the deck of cards randomly into two piles as quickly as possible. The observer should watch.
4. The observer should indicate to the timer when the sorter has finished sorting the cards.
5. The timer should note the time in seconds necessary to complete the task and tell the data recorder this number.
6. The data recorder should record the time.
7. The group should repeat Steps 1 through 6 three more times, with a different person as the card sorter each time. The group should then average the four numbers.

Have the first data recorder of each group write the average number of seconds on the board. Discuss these results with the entire class. Questions that might stimulate discussion include the following:

- Are there differences in the numbers of seconds among the groups?
- What factors may explain these differences, as well as individual differences within groups? For example, do you see a difference among:
  - males vs. females?
  - students who recently have ingested caffeine vs. those who have not?
  - students who took a class immediately prior to this one involving physical activity, such as physical education or marching band, vs. those who did not?
  - students who recently have taken an over-the-counter pain reliever, such as aspirin or ibuprofen, vs. those who have not?

Tell students that they will now perform these three additional card sorting tasks in their groups:

- **Task 2:** Sorting cards into two piles — one red pile and one black pile
- **Task 3:** Sorting cards randomly into four piles
- **Task 4:** Sorting cards into four piles — one for each suit (hearts, diamonds, clubs, spades)

Before students begin these tasks, they should predict the average time in seconds that they think will be required for the card sorters in their group to perform each of these tasks. They should answer the following questions before they make their predictions, taking into account what they know about how nerve cells transmit impulses. You may need to review terms such as neuron, neurotransmitter, synapse, and axon.

- How would the time required to perform Task 1 compare with the time required to perform each of the following tasks? Give a one sentence rationale for each of your answers:
  - Task 1 vs. Task 2?
  - Task 1 vs. Task 3?
  - Task 1 vs. Task 4?
- How would the time required to perform Task 2 compare with the time required to perform each of the following tasks? Give a one sentence rationale for each of your answers:
  - Task 2 vs. Task 3?
  - Task 2 vs. Task 4?
- How would the time required to perform Task 3 compare with the time required to perform Task 4? Give a one sentence rationale for your answer.

### **Procedures for Tasks 2, 3, and 4:**

#### ■ **Task 2**

Each group should follow these steps:

1. The card sorter should shuffle the full deck of cards again.
2. The observer should be positioned so that he/she can see the actions of the card sorter.
3. When the timer tells the sorter to begin, the sorter should deal the deck into two piles, one with all the red cards and the other pile with all the black cards, as quickly as possible. The observer should watch.
4. The observer should indicate to the timer when the sorter has finished sorting the cards.
5. The timer should note the time in seconds necessary to complete the task and tell the data recorder this number.
6. The data recorder should record the time.
7. The group should repeat Steps 1 through 6 three more times, with a different person as the card sorter each time. The group should then average the four numbers.



### ■ Task 3

Each group should follow these steps:

1. The card sorter should shuffle the full deck of cards again.
2. The observer should be positioned so that he/she can see the actions of the card sorter.
3. When the timer tells the sorter to begin, the sorter should deal the deck of cards randomly into four piles as quickly as possible. The observer should watch.
4. The observer should indicate to the timer when the sorter has finished sorting the cards.
5. The timer should note the time in seconds necessary to complete the task and tell the data recorder this number.
6. The data recorder should record the time.
7. The group should repeat Steps 1 through 6 three more times, with a different person as the card sorter each time. The group should then average the four numbers.

### ■ Task 4

Each group should follow these steps:

1. The card sorter should shuffle the full deck of cards again.
2. The observer should be positioned so that he/she can see the actions of the card sorter.
3. When the timer tells the sorter to begin, the sorter should deal the cards into four piles containing cards of only one suit; that is, a pile each of spades, diamonds, hearts, and clubs, as quickly as possible. The observer should watch.
4. The observer should indicate to the timer when the sorter has finished sorting the cards.
5. The timer should note the time in seconds necessary to complete the task and tell the data recorder this number.
6. The data recorder should record the time.
7. The group should repeat Steps 1 through 6 three more times, with a different person as the card sorter each time. The group should then average the four numbers.

Have the first data recorder of each group write the average number of seconds for each of the tasks on the board.

### **C** Concept/Term Introduction

Have the students work in cooperative groups and follow the directions in **Directions for Students** to discuss their results.

Based on field test data, some sample average student times for each of the **Exploration** tasks are as follows:

Task 1: 25 seconds

Task 2: 28 seconds

Task 3: 30 seconds

Task 4: 45 seconds

These numbers can be represented on a bar graph as follows:

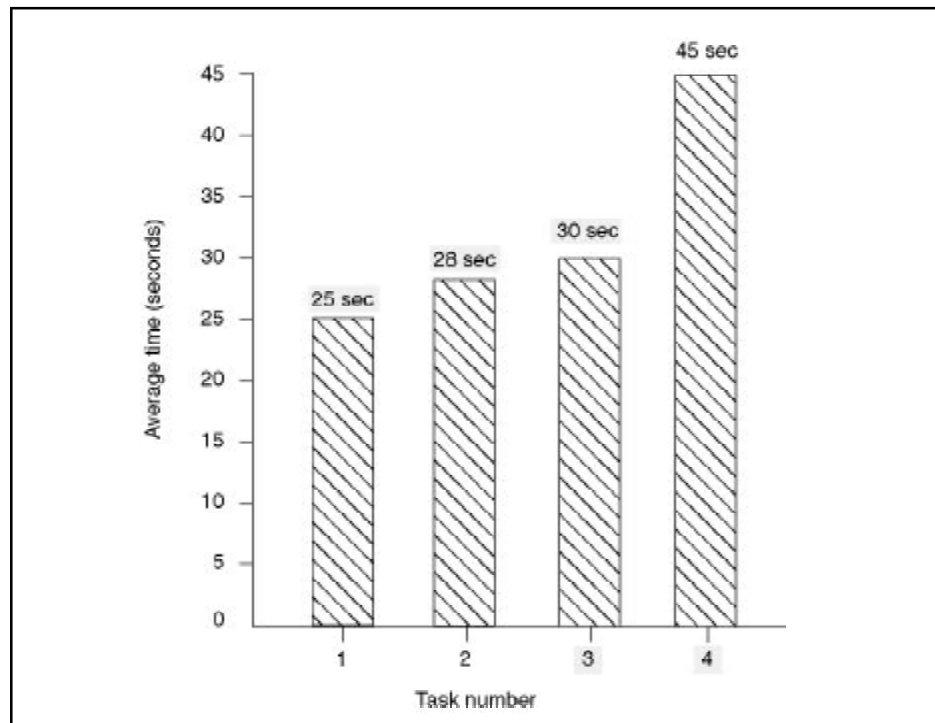

*Graph 1. Sample average times in seconds required to complete exploration tasks.*

*Group Discussion:* Designate one person in each group to be the group discussion coordinator. Each group will analyze the data and brainstorm ideas about what occurred in the **Exploration** and why. The group discussion coordinator will monitor each group. The teacher may place the following list of suggested questions for group data analysis discussion on the board, or the list may be given to the group discussion coordinators to use while monitoring the brainstorm portion of the activity. Have students also answer the **Focus Questions in Directions for Students**.

- Which task took the greatest amount of time for your group?
- Which task took the shortest amount of time for your group?
- Were the results what you expected?

- How do you explain your group's results for each of the last three tasks?
- Were the results for each of the last three tasks similar to those of other groups? If not, how might you explain any differences?
- What is the difference in the time required for Task 4 for your group and the time required for Task 1? Task 4 vs. Task 2? How do you explain these differences?
- Subtract the Task 3 time from the Task 4 time for your group. What does this difference represent? Why does this difference exist?
- Subtract the Task 1 time from the Task 2 time for your group. What does this difference represent? Why does this difference exist?

Have each group share its explanations with the class.

*Drawings of Neural Circuitry Models:* After students have discussed the results in their groups and shared their explanations with the class, you may want to follow the suggested procedure below:

1. Have students follow the directions in **Directions for Students** as they draw a neural circuitry model to represent each of the four tasks. See Sample Neural Circuitry Models in Figures 4a through 4d.
2. Check the student diagrams. If the students are having difficulty getting started with this task, you may want to show them an overhead transparency of Figure 4a, and ask which of the tasks it represents and why. If they still need help, you might ask them how the diagram would change with a more complex task, and why.
3. Listen to the group discussions to be sure students do not have misconceptions about the tasks. Address and try to correct any student misconceptions you hear.
4. After students have drawn and compared their models, have them present and discuss these with the class.
5. Show students overhead transparencies and/or photocopies of correct models (Figures 4a through 4d). Be sure students correct any errors they made on the models they drew themselves, and that they understand how synapses and postsynaptic integration slow down the transmission of information along a nerve pathway. It is very important that students understand the major concepts in this activity before designing experiments on their own.

### **A Application**

Students can now build on their previous experiences to extend the **Exploration** tasks and learn more about reaction time and neural circuitry. Have them work in their groups to design and conduct their experiments and analyze their data. Afterwards, each group should share its results with other members of the class.

Experiments should assess other factors that influence sorting time. These factors may include the following:

- Practice

### SAMPLE HYPOTHESES

● If competition is involved in performing the **Exploration** card-sorting tasks, then the time for sorting cards competitively will be decreased on all four of the tasks as compared to performing the tasks with no competition.

▲ If students repeatedly perform the **Exploration** card sorting tasks, then the time for sorting cards will be decreased on all four of the tasks as compared to performing the tasks one time only.

### SAMPLE PROCEDURES

● Students in two separate Biology I classes in the same school will perform the experiment. One class will have students divided randomly into groups of four. Each group will perform all four tasks as described in the **Exploration** phase of this activity. The other class will also have students divided randomly into groups of four and perform all four tasks as described in the **Exploration** activity. The only difference between the two classes will be that in the second class, the students will be told ahead of time that the group with the lowest average numbers on all four tasks will receive a reward, to be chosen by the teacher. The average times for each task for each of the two classes will be compared to determine whether competition in the second class was related to students sorting the cards more quickly.

▲ Students in a Biology I class will be divided ran-

— Continued

- Attention/distraction
- Learning
- Age
- Stress
- Competition
- Visual acuity
- Gender
- Length of arms
- Sleep deprivation
- Soft drinks containing caffeine
- Day of the week: Monday vs. Wednesday, for example
- Over-the-counter drugs, such as ibuprofen, aspirin, antihistamines.

Questions you might ask students to help them start thinking about their own experiments include the following. Refer to the **Teacher Background** information for the answers to these questions.

- Is there a point at which reaction time can't be shorter?
- If a distraction occurs during the activity — such as loud noises, someone talking to the student, someone tapping a ruler on a desk, or music — does the reaction time increase?
- If a student performs some rote memory task, such as saying the multiplication tables out loud while performing a discrimination task, is reaction time affected?

Your students probably will develop other questions related to reaction time and neural circuitry. In the sidebar are sample hypotheses and procedures that students might derive related to this activity. These examples have been included as suggested outcomes of the activity and are not meant to be given to the students. Students should develop their own hypotheses and procedures. Make sure they understand that there is not just one correct hypothesis and procedure.

### Answers to Questions in “Directions for Students”

#### **Concept/Term Introduction**

#### **Focus Questions**

1. Occipital lobe.
2. Motor cortex (precentral gyrus) in the frontal lobe and the cerebellum.
3. Visual system (occipital lobe), motor system (precentral gyrus in the frontal lobe), and association areas (frontal lobe).
4. No. Random sorting doesn't require the visual system.
5. These drugs could increase, decrease, or have no effect on reaction time depending on the dose. Caffeine and cocaine might increase reaction time unless doses are high.

## Using the Cognitive Neuroscience Demonstration Programs and Corresponding Pen and Paper Exercises

The “Cognitive Neuroscience Demonstration Programs” give students the opportunity to explore basic attentional, learning, and language phenomena by measuring their reaction time on different tasks. Students can design labs around any one of the six exercises provided. These computer programs are available on an Internet web site, and can be downloaded and run on a Macintosh computer. To access and download the programs, follow the procedures outlined on the following web page: <http://www.npg.wstu.edu/petersen>.

These programs run on any Macintosh computer, but currently are not available for IBM computers. To begin, double-click with the mouse on the icon for the program. The directions for each activity will appear on the screen. Upon completion of each exercise, an interpretation of the results will also appear on the screen. However, students will need to further interpret these results in light of their own experimental designs and the concepts introduced with this activity.

Pen and paper exercises have also been developed based on these computer programs. These exercises can be used alone or in conjunction with the computer programs. The pen and paper exercises are part of a laboratory manual and can be ordered from Prentice-Hall. The ordering information is:

“The human brain and memory: Using behavioral measures to study cognitive functions”; a laboratory investigation published in *Lab Physiology Manual* (1996); D.U. Silverthorn, B. Johnson & A.C. Mills, Editors; Prentice-Hall, Inc.; Englewood Cliffs, NJ 07632.

### References

Guyton, A.C. (1991). *Textbook of medical physiology*. 8th ed. Philadelphia, PA: W.B. Saunders Company; Harcourt Brace Jovanovich, Inc.

### Suggested Reading

Kandel E., Schwartz J. & Jessell, T. (Eds.). (1991). *Principles of neural science*. 3rd ed. New York: Elsevier Science Publishing Company.

Nicholls, J.G., Martin, R.A. & Wallace, B.G. (1992). *From neuron to brain*. Sunderland, MA: Sinauer Associates, Inc.

Posner, M.I. (1988). Localization of cognitive operation in the human brain. *Science*, 240, 1627–1631.

Sacks, O. (1985). “The disembodied lady” in *The man who mistook his wife for a hat and other clinical tales*. New York: HarperCollins. (pp. 43–54).

Society for Neuroscience. (1991). In J. Carey (Ed.), *Brain facts: A primer on the brain and nervous system*. Washington, DC: Society for Neuroscience.

Solomon, E., Schmidt, R. & Adragna, P. (1990). *Human anatomy and physiology*. Florida: Saunders College Publishing.

### SAMPLE PROCEDURES

#### —Continued

domly into groups of four. Each group will perform all four tasks as described in the **Exploration** phase of this activity, with only one person being the card sorter each time, and the same person being the card sorter in all four tasks. Each group will then repeat all four tasks three more times, with the same person in each group as before being the card sorter each time. The times for each task for each group will be compared on all four trials to determine whether practice in the form of repetition was related to students sorting the cards more quickly.



# REACTION TIME AND NEURAL CIRCUITRY

## Directions for Students

### Introduction

We are excited and amazed at some of the feats accomplished by our best athletes. Whether it be catching a 50-yard pass while running at “lightning” speed, or shooting that three-point basket in the last seconds of an important

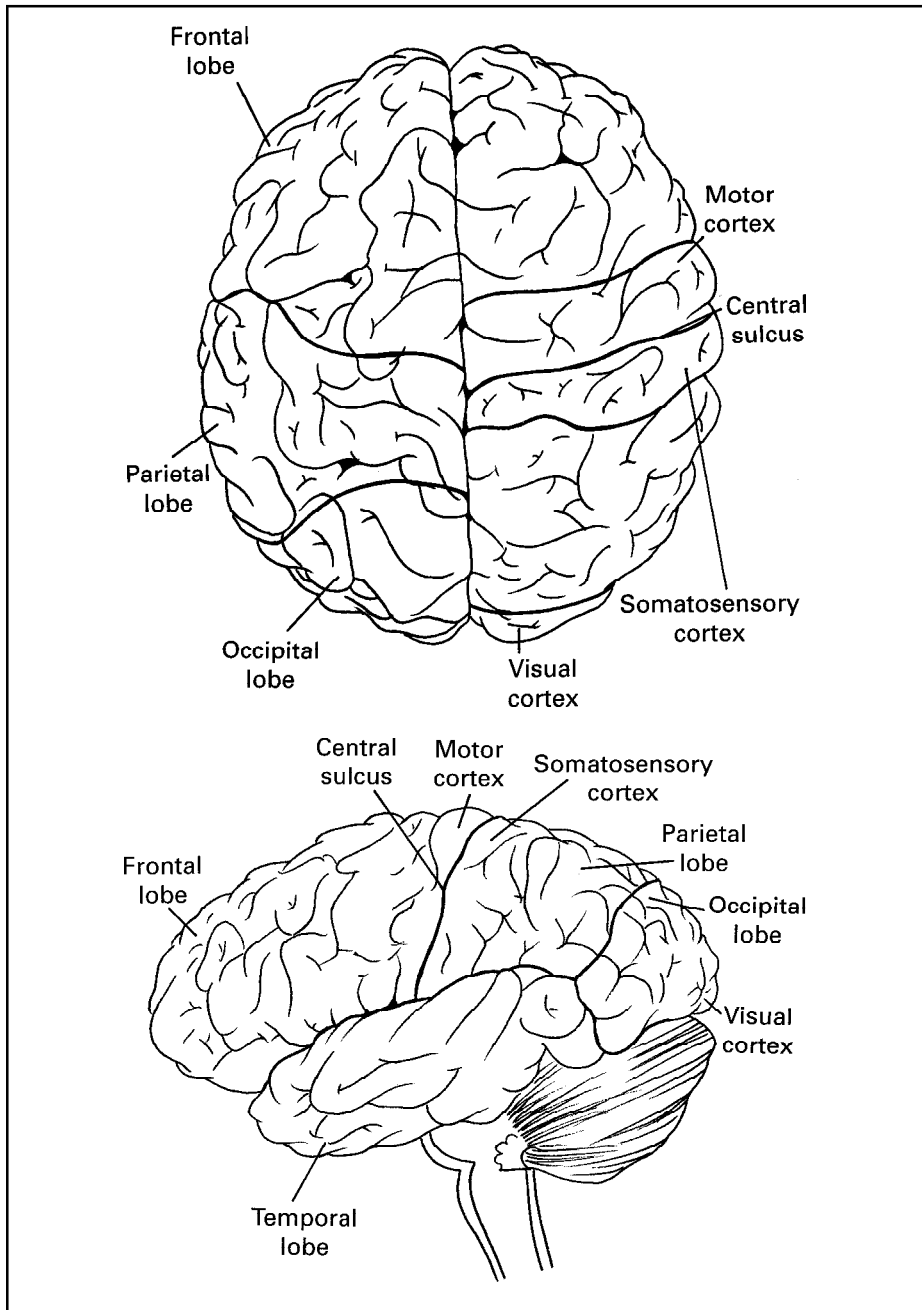

Figure 1. Major divisions of the human cerebral cortex: (a) dorsal view, (b) lateral view of left hemisphere.

### MATERIALS

Materials will be provided by your teacher and consist of the following per group:

- 1 deck of playing cards
- 1 watch/clock with a second timer

 **SAFETY NOTES**  
None needed.

game, we cheer their accomplishments. In fact, though, each of us in our everyday lives performs highly skilled movements that are no less amazing. Activities such as talking and writing are so commonplace that we take for granted the tremendous amount of coordination and brain activity necessary to accomplish them.

In this lab, you will perform some simple tasks to study the ability of the brain to handle different kinds of tasks. Different tasks require different levels of discrimination that affect reaction time. At the same time, you will learn some important concepts about the workings of the nervous system.

## Procedure

### **E** Exploration

Your teacher will lead you through four **Exploration** activities. Follow your teacher's directions.

### **C** Concept/Term Introduction

Work with your teacher and other students to analyze the data just gathered. Develop an explanation of what took place.

1. Draw a bar graph of the data your group obtained in Tasks 1 through 4. Analyze the data and brainstorm ideas about what occurred and why in the **Exploration** tasks. Each group will have a discussion coordinator to monitor this discussion.

Work with your teacher and other students to learn more about reaction time and neural circuitry. Your teacher may suggest that you work in your groups and draw neural diagrams of what took place. Draw a different diagram to represent each of the four tasks done in the **Exploration** phase. Remember to use what you know about neurons and how they transmit information.

Compare your diagrams with those drawn by your group members. Check your diagrams against those presented by your teacher. How do they compare? What conclusions can you draw?

### FOCUS QUESTIONS

Using your textbook or other materials supplied by your teacher, answer the following questions:

1. What part of the brain processes vision stimuli?
2. What part of the brain is responsible for the coordination required to shuffle the cards?
3. Which parts of the brain were involved in completion of Tasks 1–4?
4. Are the same parts of the brain involved in each of the tasks?



## FOCUS QUESTIONS

— Continued

5. What effects do you suppose the following drugs might have on reaction time: alcohol, nicotine, cocaine, marijuana, caffeine? Why?

### **A** Application

Think of questions that arose as you conducted the **Exploration** activities, discussed your results, and drew your diagrams. Decide as a group what question you wish to test. Then design an experiment to test that question. Write your procedure in a numbered list. Make sure that your group does the following:

- Writes the question as a hypothesis or in the form of an “if...then” statement.
- Gathers quantifiable data.
- Decides what variables must be controlled and plans how to control them.

**Teacher approval must be obtained  
before you begin this activity!**

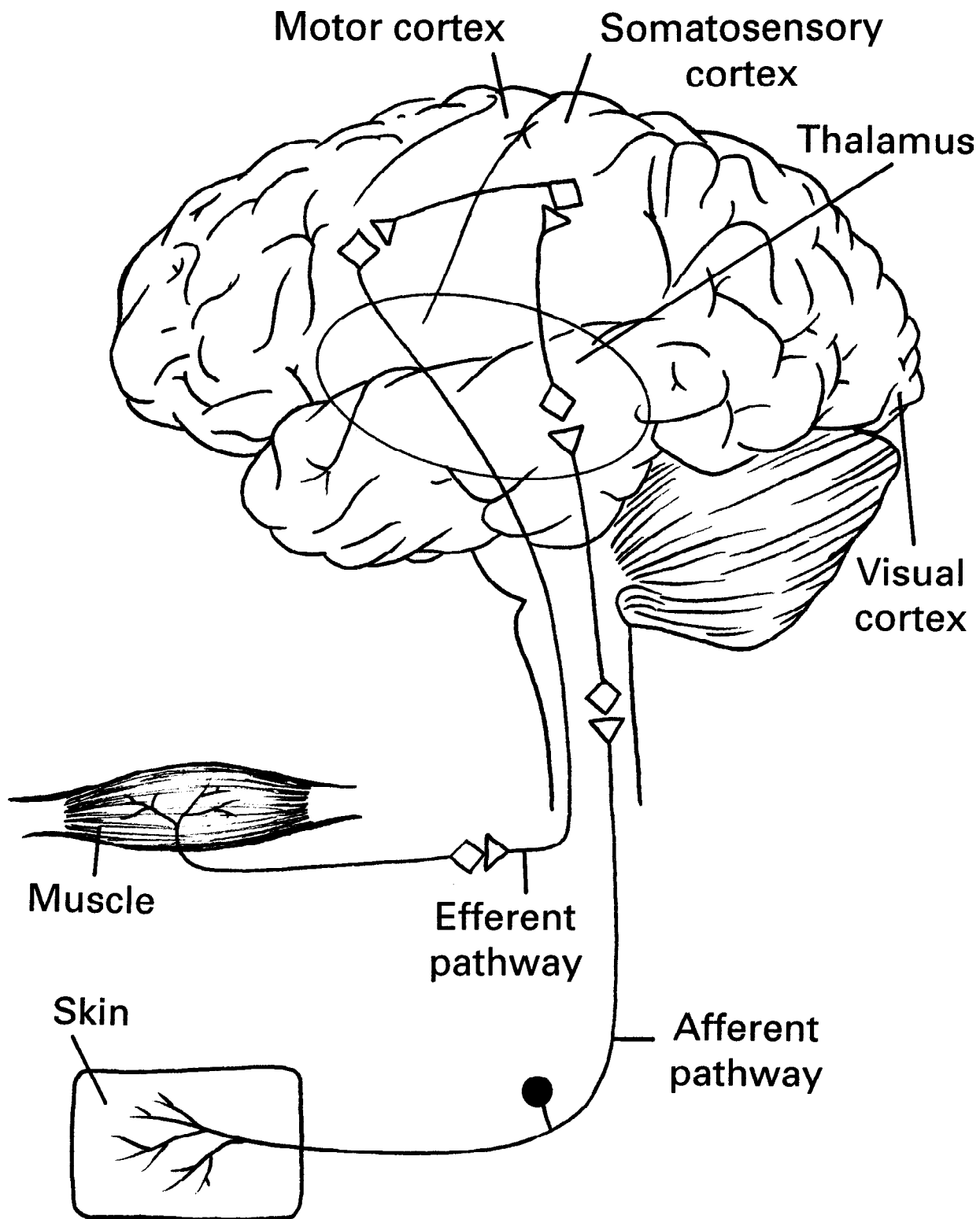

Figure 1. A nerve pathway that involves several areas of the brain. Note the number of synapses involved.

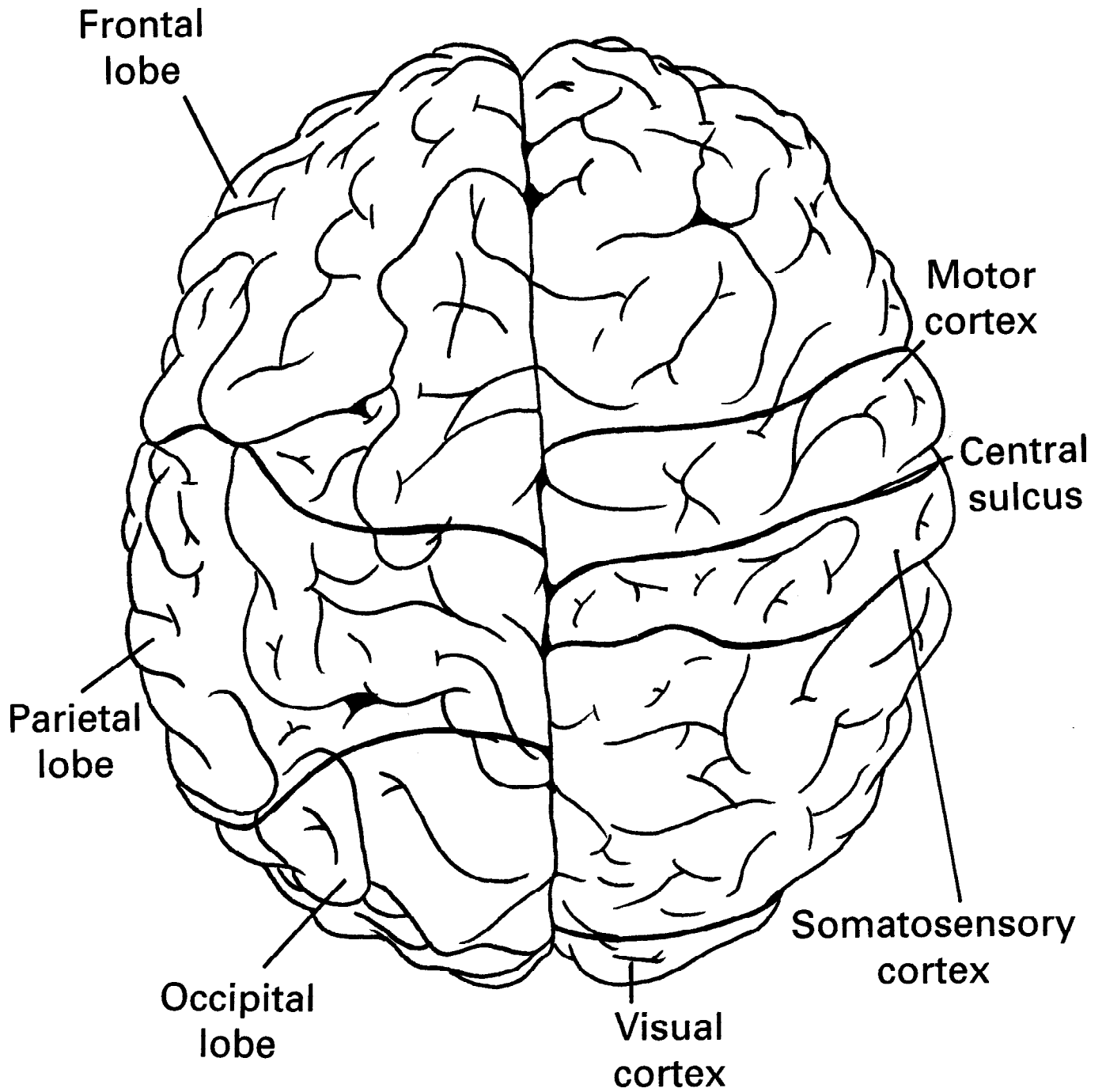

Figure 2. Major divisions of the human cerebral cortex: (a) dorsal view.

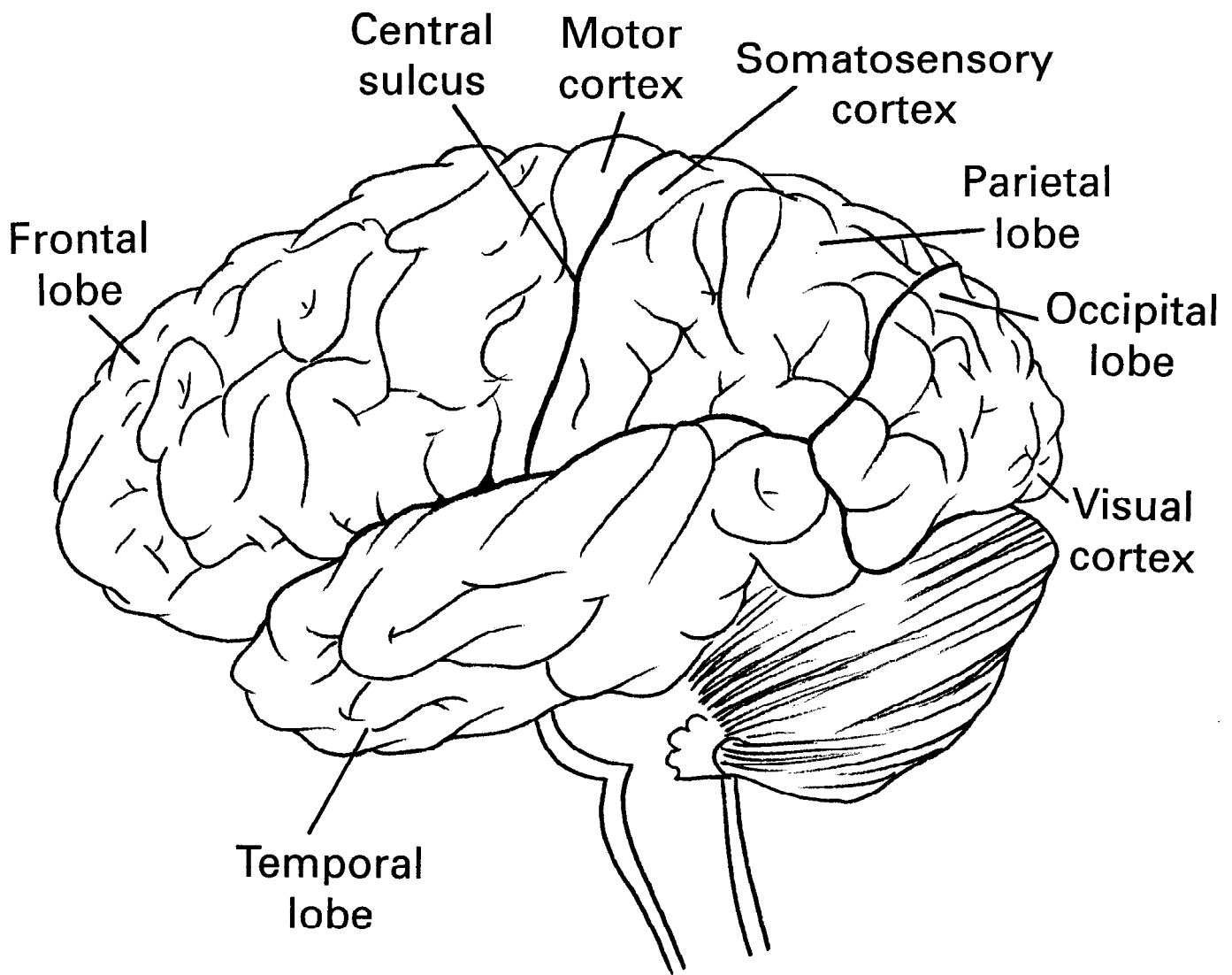
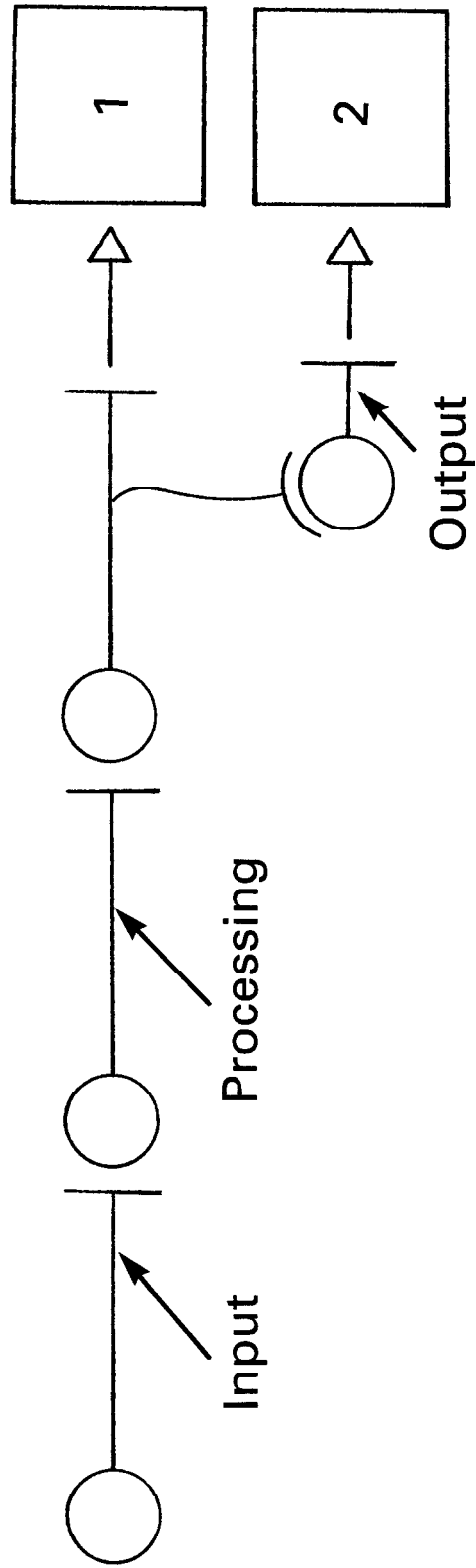

Figure 2. Major divisions of the human cerebral cortex: (b) lateral view of left hemisphere.

4a. Task 1 (Random sorting into two piles)



Figures 4a through 4d. Schematic diagrams of neural processes involved in card sorting tasks.

4b. Task 2 (Two piles, red or black)

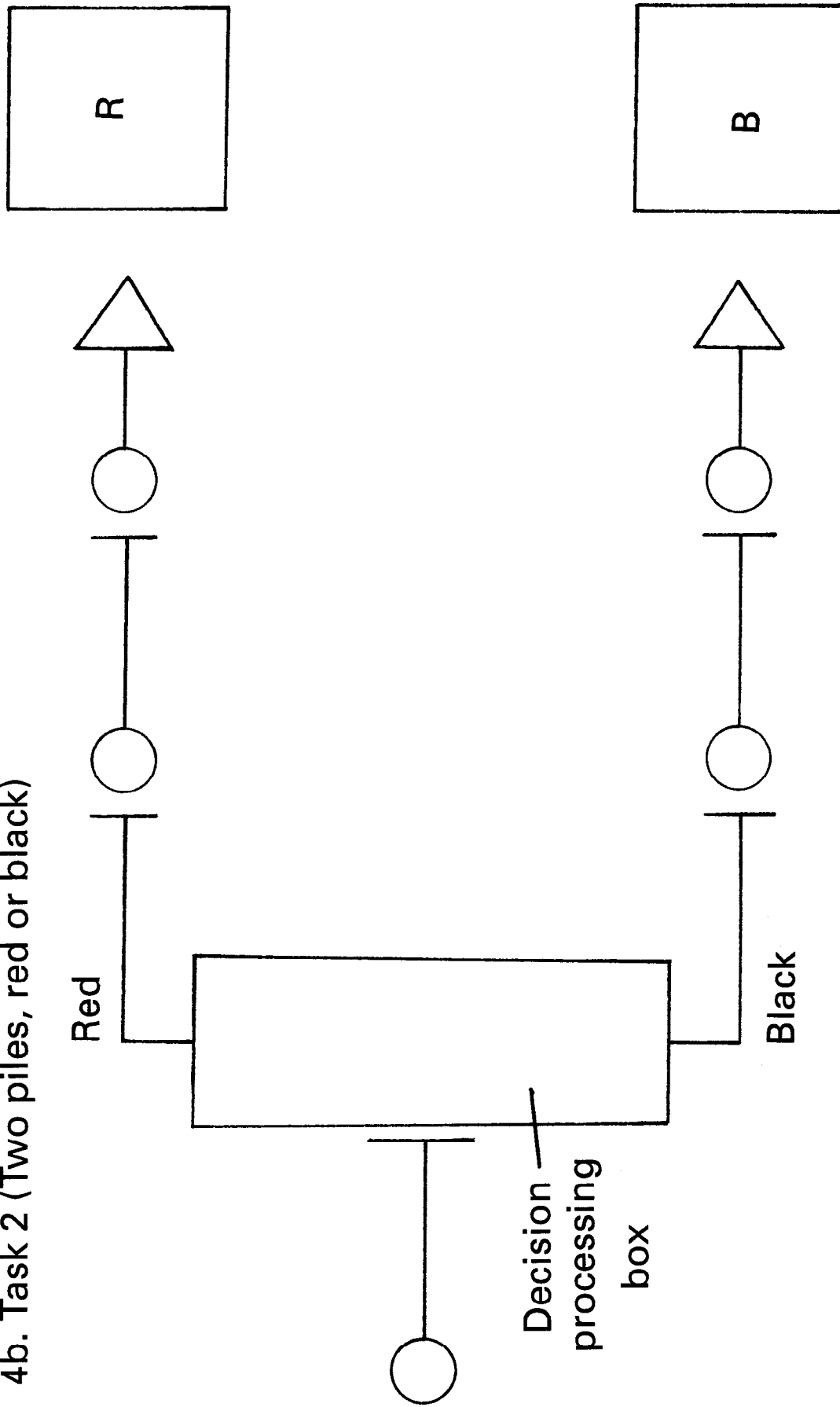

Processing now involves a decision (several neurons in the association cortex).

Figures 4a through 4d. Schematic diagrams of neural processes involved in card sorting tasks.

4c. Task 3 (Random sorting into four piles)

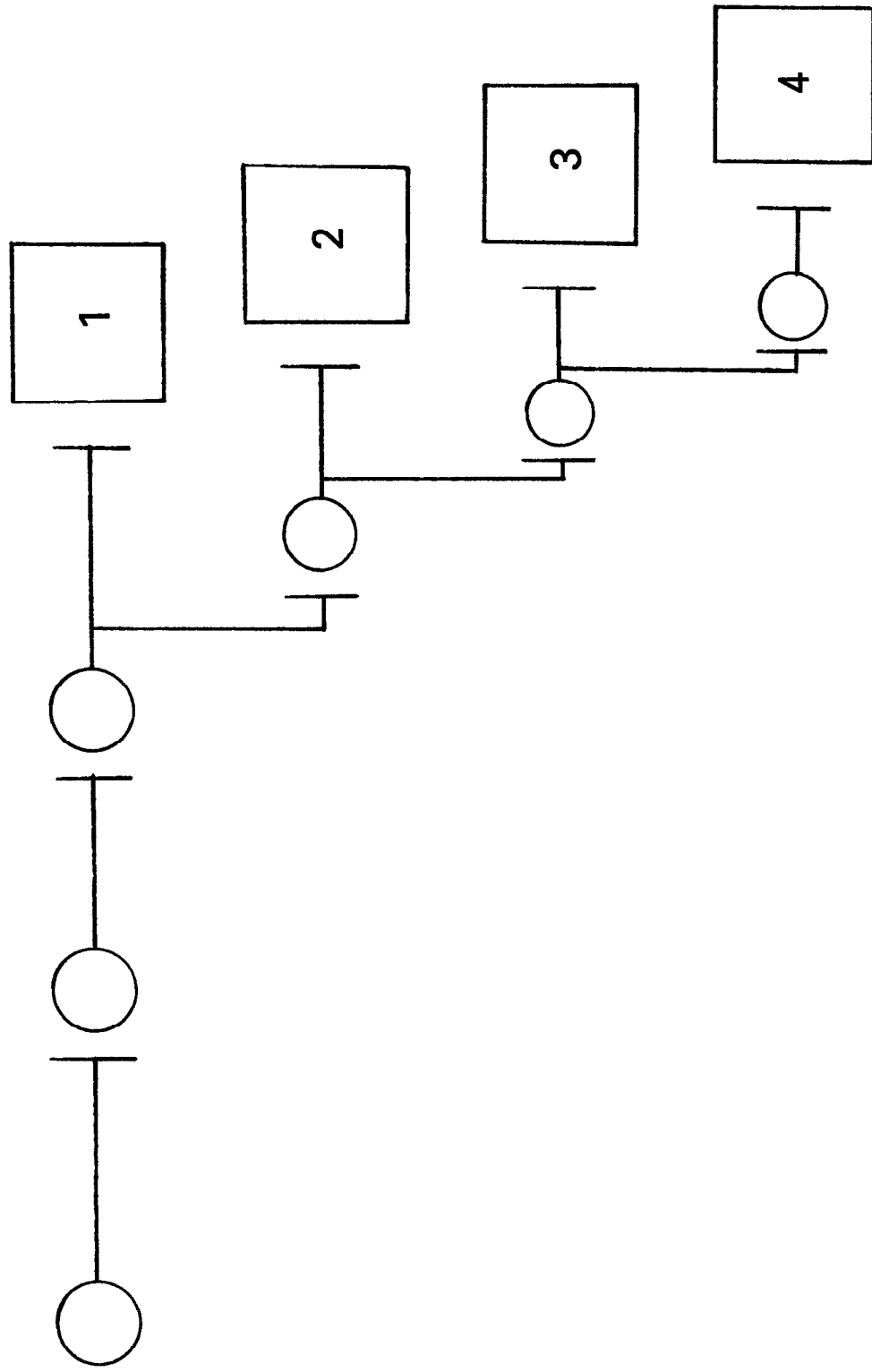

Figures 4a through 4d. Schematic diagrams of neural processes involved in card sorting tasks.

#### 4d. Task 4 (Four piles, four suits)

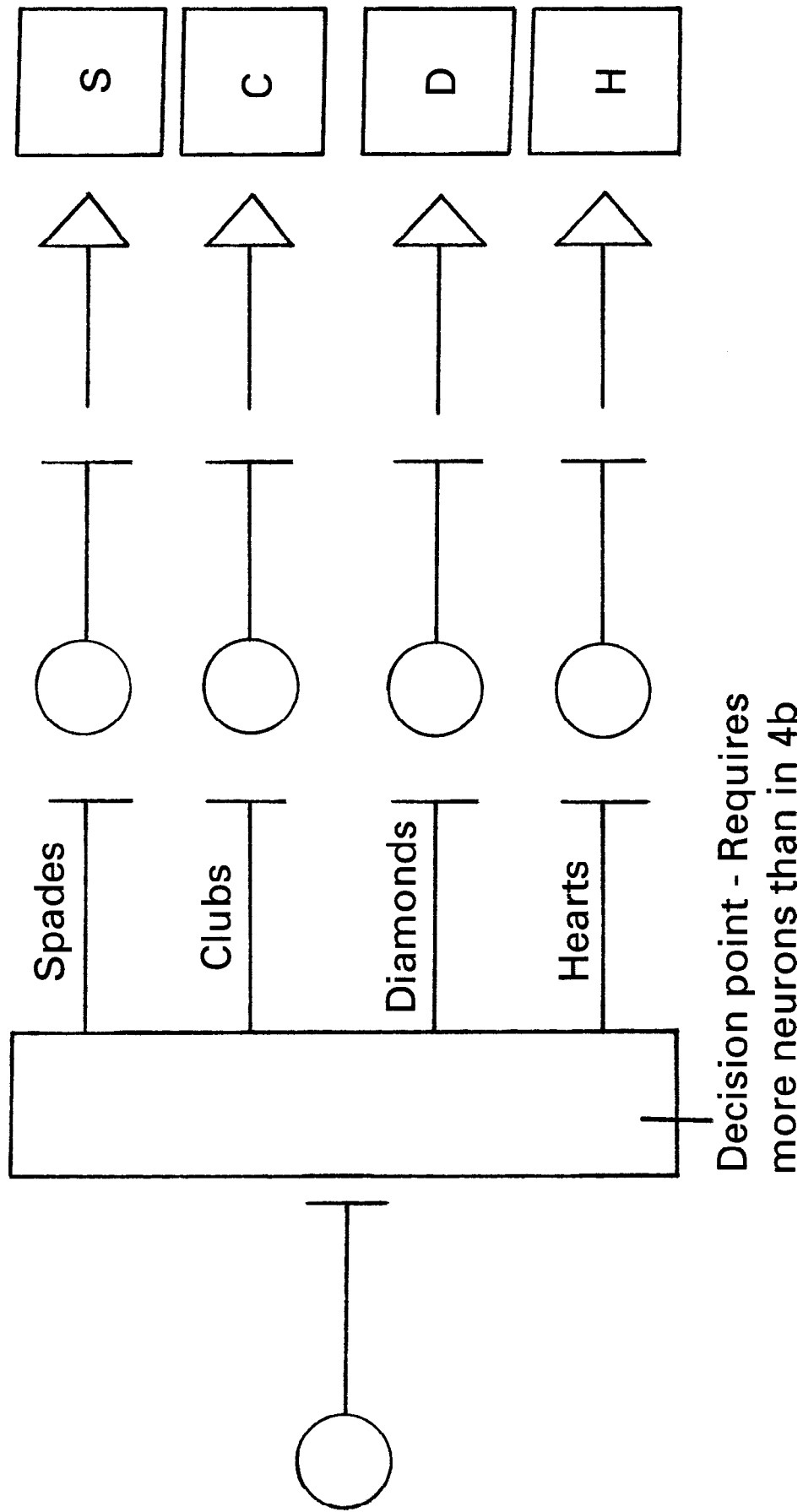

Figures 4a through 4d. Schematic diagrams of neural processes involved in card sorting tasks.